

LVI634B - Technical Data Sheet

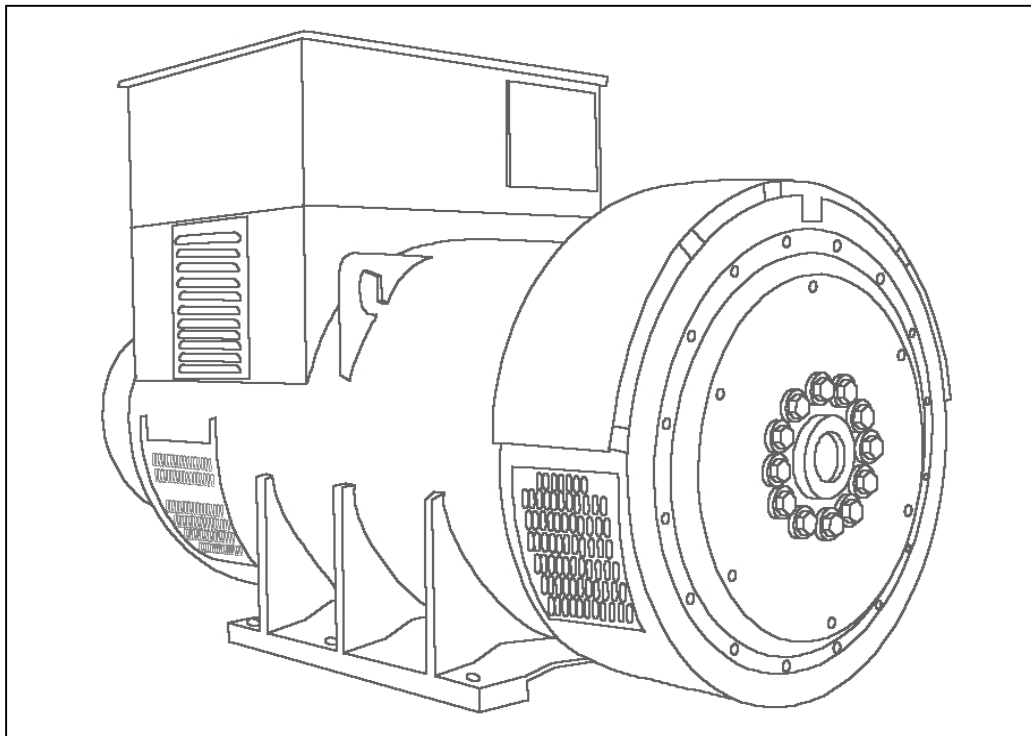

LVI634B

SPECIFICATIONS & OPTIONS



STANDARDS

Newage Stamford industrial generators meet the requirements of BS EN 60034 and the relevant section of other international standards such as BS5000, VDE 0530, NEMA MG1-32, IEC34, CSA C22.2-100, AS1359. Other standards and certifications can be considered on request.

VOLTAGE REGULATORS

MX341 AVR

This sophisticated AVR is incorporated into the Stamford Permanent Magnet Generator (PMG) control system.

The PMG provides power via the AVR to the main exciter, giving a source of constant excitation power independent of generator output. The main exciter output is then fed to the main rotor, through a full wave bridge, protected by a surge suppressor. The AVR has in-built protection against sustained over-excitation, caused by internal or external faults. This de-excites the machine after a minimum of 5 seconds.

An engine relief load acceptance feature can enable full load to be applied to the generator in a single step.

If three-phase sensing is required with the PMG system the MX321 AVR must be used.

We recommend three-phase sensing for applications with greatly unbalanced or highly non-linear loads.

MX321 AVR

The most sophisticated of all our AVRs combines all the features of the MX341 with, additionally, three-phase rms sensing, for improved regulation and performance.

Over voltage protection is built-in and short circuit current level adjustments is an optional facility.

WINDINGS & ELECTRICAL PERFORMANCE

All generator stators are wound to 2/3 pitch. This eliminates triplen (3rd, 9th, 15th ...) harmonics on the voltage waveform and is found to be the optimum design for trouble-free supply of non-linear loads. The 2/3 pitch design avoids excessive neutral currents sometimes seen with higher winding pitches, when in parallel with the mains. A fully connected damper winding reduces oscillations during paralleling. This winding, with the 2/3 pitch and carefully selected pole and tooth designs, ensures very low waveform distortion.

TERMINALS & TERMINAL BOX

Standard generators feature a main stator with 6 ends brought out to the terminals, which are mounted on the frame at the non-drive end of the generator. A sheet steel terminal box contains the AVR and provides ample space for the customers' wiring and gland arrangements. It has removable panels for easy access.

SHAFT & KEYS

All generator rotors are dynamically balanced to better than BS6861:Part 1 Grade 2.5 for minimum vibration in operation. Two bearing generators are balanced with a half key.

INSULATION/IMPREGNATION

The insulation system is class 'H'.

All wound components are impregnated with materials and processes designed specifically to provide the high build required for static windings and the high mechanical strength required for rotating components.

QUALITY ASSURANCE

Generators are manufactured using production procedures having a quality assurance level to BS EN ISO 9001.

The stated voltage regulation may not be maintained in the presence of certain radio transmitted signals. Any change in performance will fall within the limits of Criteria 'B' of EN 61000-6-2:2001. At no time will the steady-state voltage regulation exceed 2%.

NB Continuous development of our products entitles us to change specification details without notice, therefore they must not be regarded as binding.

Front cover drawing typical of product range.

LVI634B WINDING 312

CONTROL SYSTEM		SEPARATELY EXCITED BY P.M.G.							
A.V.R.		MX341	MX321						
VOLTAGE REGULATION		± 1.0 %	± 0.5 %	With 4% Engine Governing					
SUSTAINED SHORT CIRCUIT		REFER TO SHORT CIRCUIT DECREMENT CURVES (page 7)							
INSULATION SYSTEM		CLASS H							
PROTECTION		IP23							
RATED POWER FACTOR		0.8							
STATOR WINDING		DOUBLE LAYER LAP							
WINDING PITCH		TWO THIRDS							
WINDING LEADS		6							
STATOR WDG. RESISTANCE		0.0039 Ohms PER PHASE AT 22°C STAR CONNECTED							
ROTOR WDG. RESISTANCE		1.6 Ohms at 22°C							
R.F.I. SUPPRESSION		BS EN 61000-6-2 & BS EN 61000-6-4, VDE 0875G, VDE 0875N. refer to factory for others							
WAVEFORM DISTORTION		NO LOAD < 1.5% NON-DISTORTING BALANCED LINEAR LOAD < 5.0%							
MAXIMUM OVERSPEED		2250 Rev/Min							
BEARING DRIVE END		BALL. 6228 (ISO)							
BEARING NON-DRIVE END		BALL. 6319 (ISO)							
		1 BEARING			2 BEARING				
WEIGHT COMP. GENERATOR		1985 kg			2030 kg				
WEIGHT WOUND STATOR		865 kg			865 kg				
WEIGHT WOUND ROTOR		760 kg			716 kg				
WR ² INERTIA		16.7816 kgm ²			16.2382 kgm ²				
SHIPPING WEIGHTS in a crate		2023 kg			2045 kg				
PACKING CRATE SIZE		183 x 92 x 140 (cm)			183 x 92 x 140 (cm)				
		50 Hz			60 Hz				
TELEPHONE INTERFERENCE		THF<2%			TIF<50				
COOLING AIR		2.18 m ³ /sec 4619 cfm			2.63 m ³ /sec 5573 cfm				
VOLTAGE STAR (Y)		380/220	400/231	415/240	440/254	416/240	440/254	460/266	480/277
kVA BASE RATING FOR REACTANCE VALUES		710	750	750	680	810	855	895	938
Xd DIR. AXIS SYNCHRONOUS		2.73	2.60	2.42	1.95	3.12	2.94	2.82	2.71
X'd DIR. AXIS TRANSIENT		0.17	0.16	0.15	0.12	0.20	0.18	0.18	0.17
X''d DIR. AXIS SUBTRANSIENT		0.12	0.12	0.11	0.09	0.14	0.13	0.13	0.12
Xq QUAD. AXIS REACTANCE		2.27	2.16	2.01	1.62	2.59	2.44	2.34	2.25
X''q QUAD. AXIS SUBTRANSIENT		0.28	0.27	0.25	0.20	0.32	0.30	0.29	0.28
XL LEAKAGE REACTANCE		0.10	0.09	0.09	0.07	0.11	0.11	0.10	0.10
X ₂ NEGATIVE SEQUENCE		0.20	0.20	0.18	0.15	0.23	0.22	0.21	0.20
X ₀ ZERO SEQUENCE		0.03	0.03	0.02	0.02	0.03	0.03	0.03	0.03
REACTANCES ARE SATURATED		VALUES ARE PER UNIT AT RATING AND VOLTAGE INDICATED							
T'd TRANSIENT TIME CONST.		0.106 s							
T''d SUB-TRANSTIME CONST.		0.013 s							
T'do O.C. FIELD TIME CONST.		2.91 s							
Ta ARMATURE TIME CONST.		0.035 s							
SHORT CIRCUIT RATIO		1/Xd							

**50
Hz**

LVI634B
Winding 312



THREE PHASE EFFICIENCY CURVES

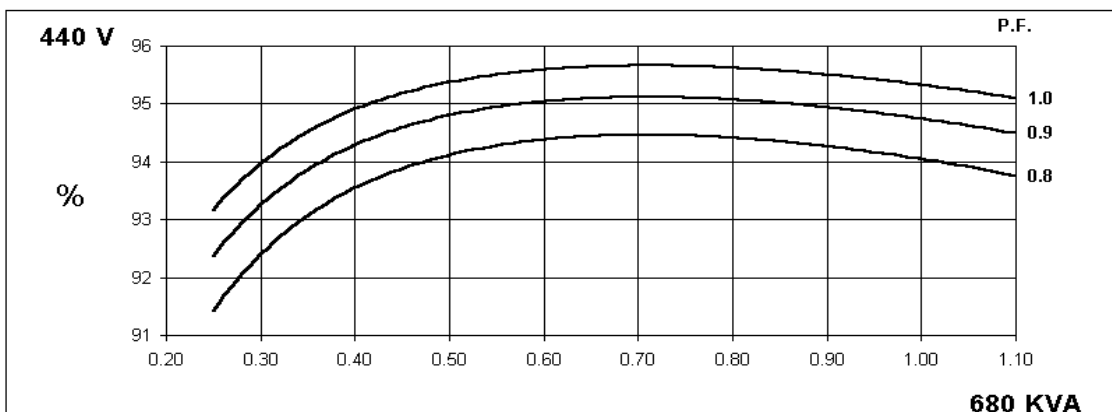
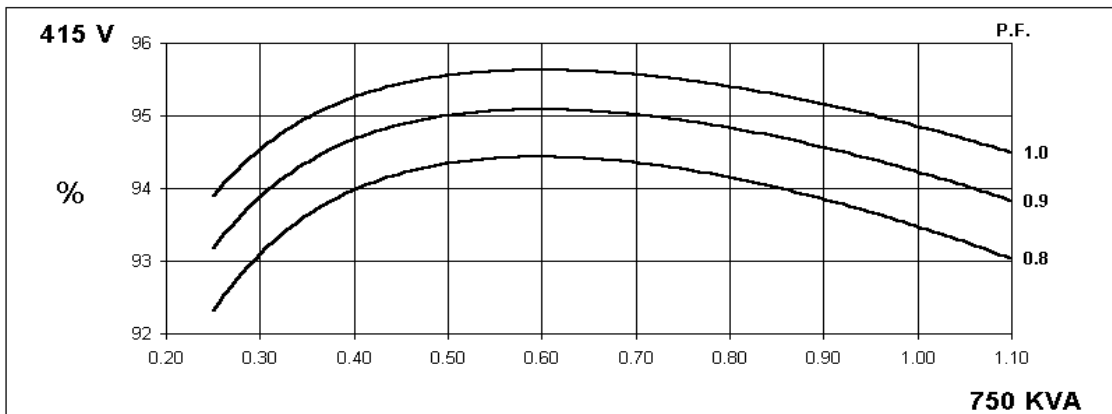
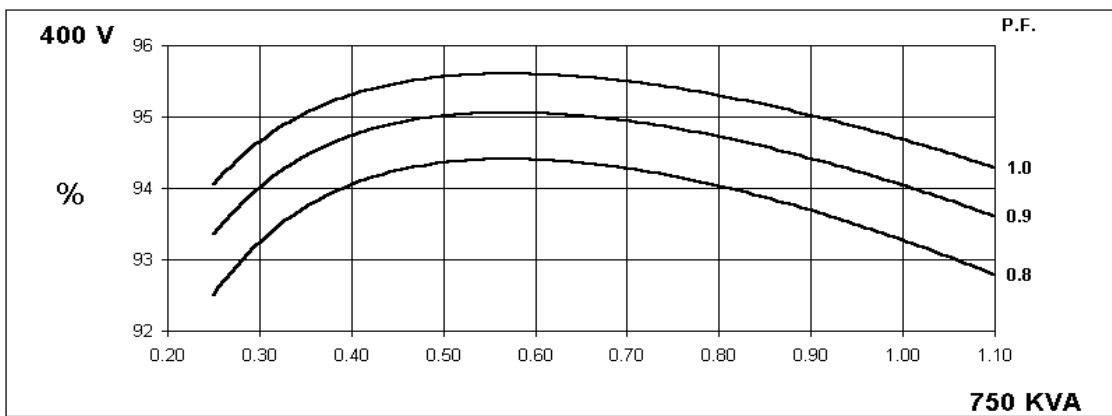
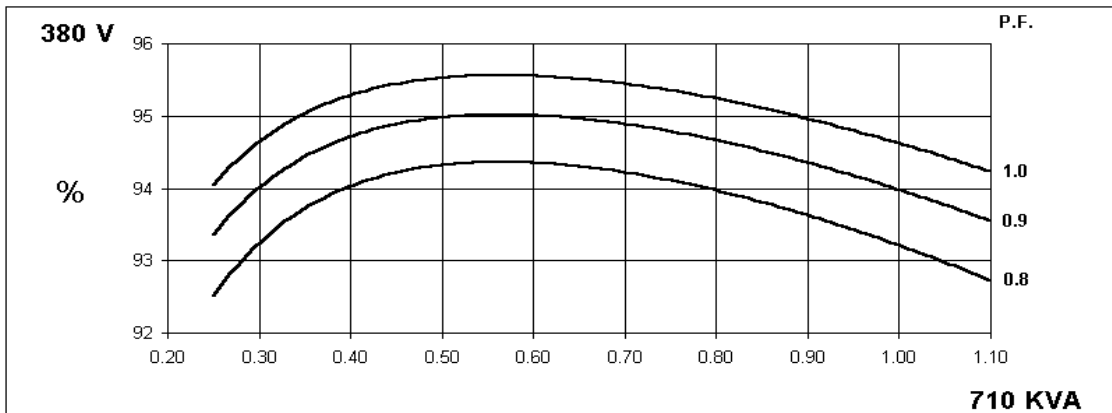

THREE PHASE EFFICIENCY CURVES

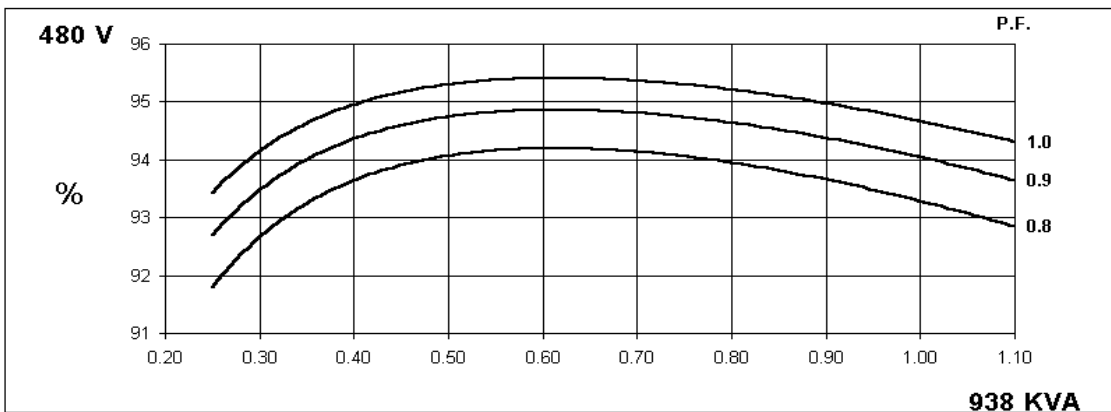
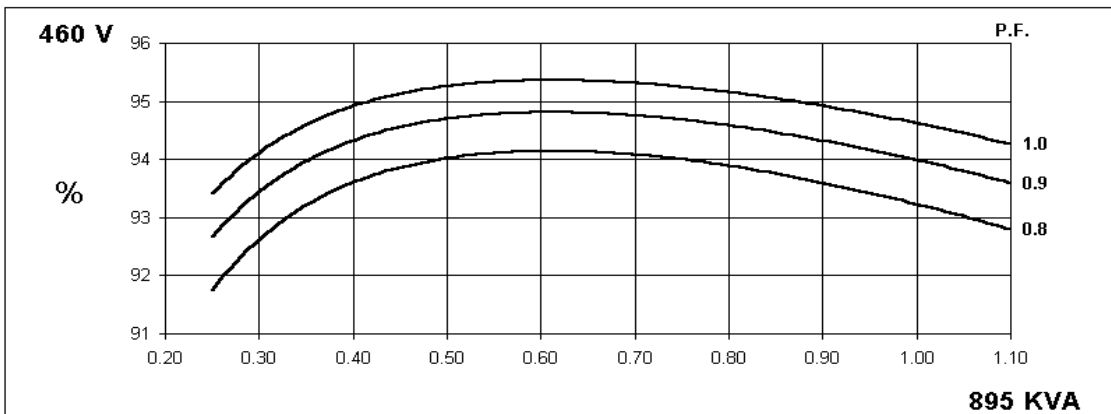
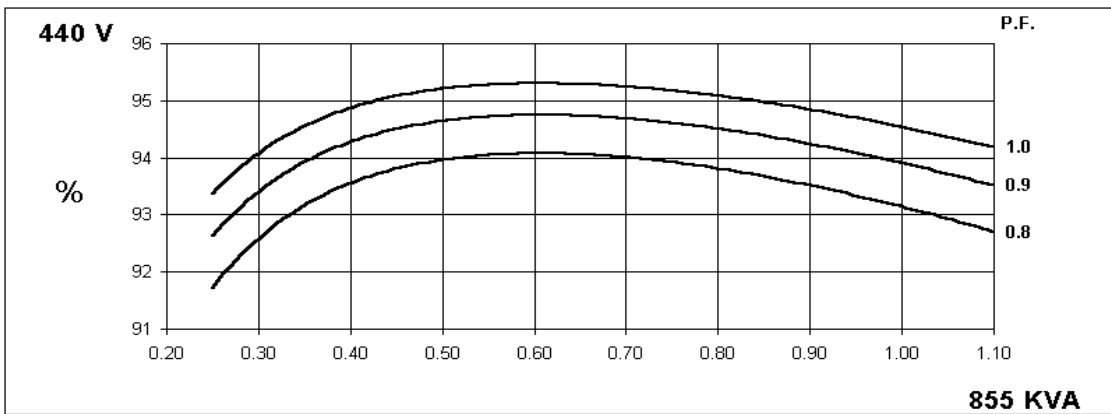
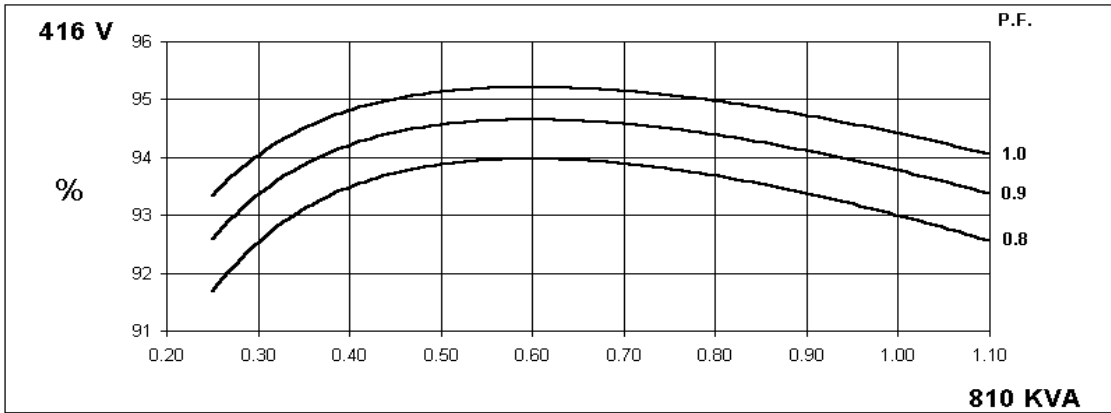

LVI634B
Winding 312



Locked Rotor Motor Starting Curve

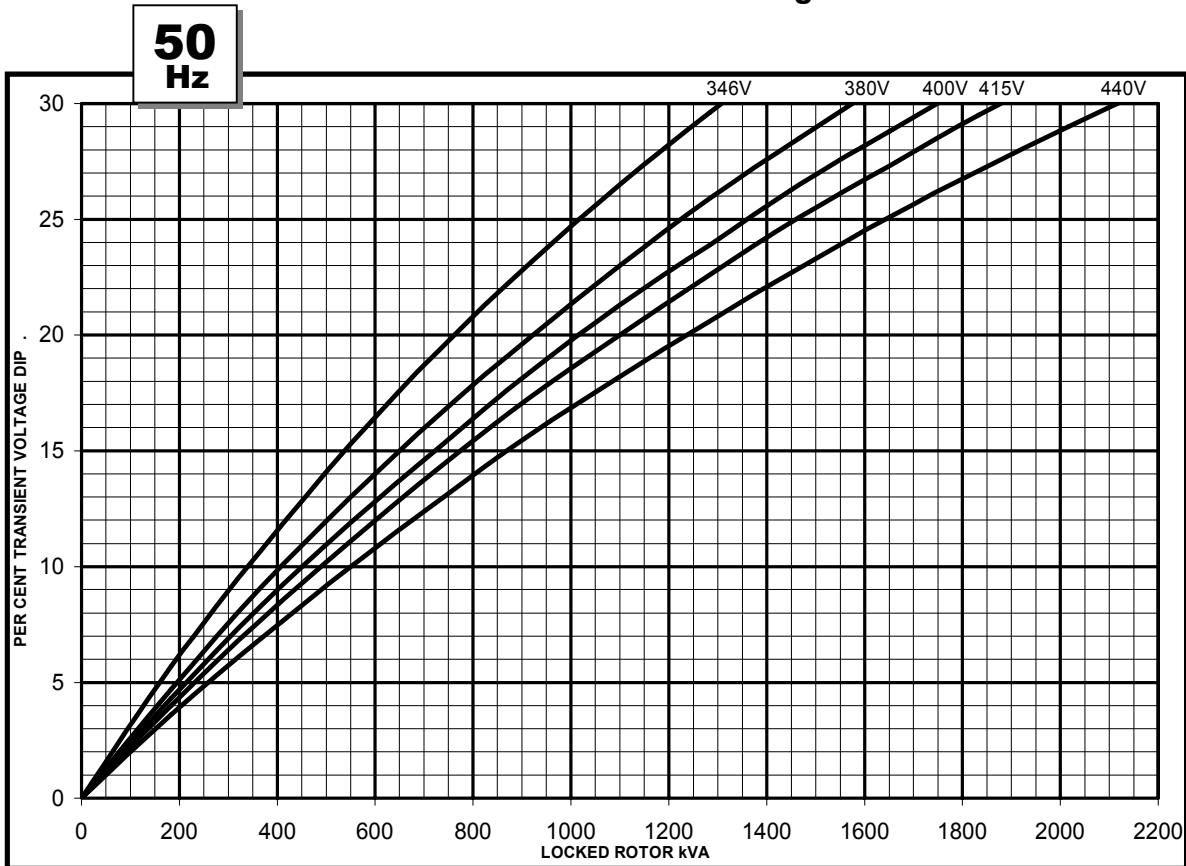

**Three-phase Short Circuit Decrement Curve. No-load Excitation at Rated Speed
Based on star (wye) connection.**

**50
Hz**

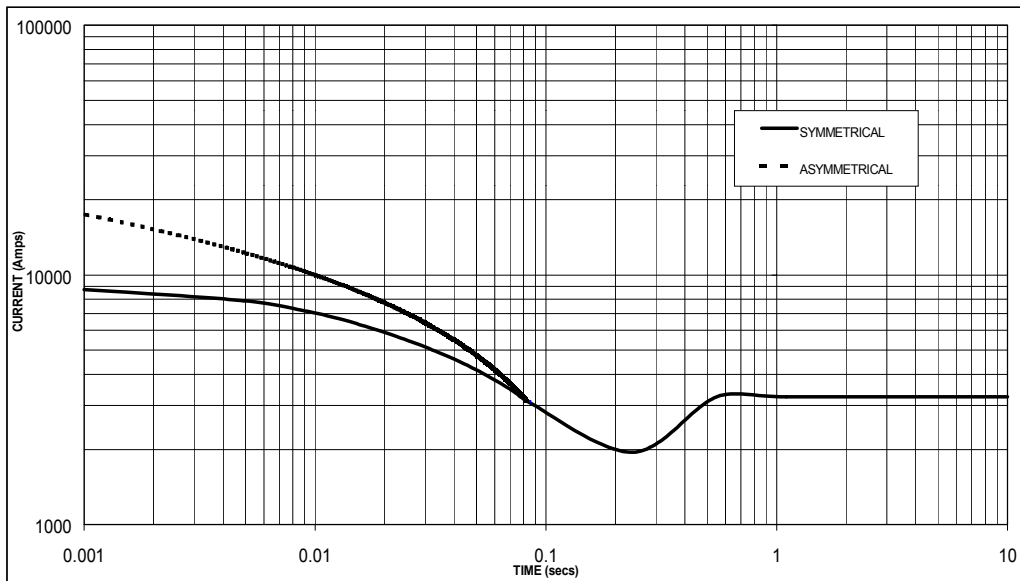

Sustained Short Circuit = 3,250 Amps

**60
Hz**

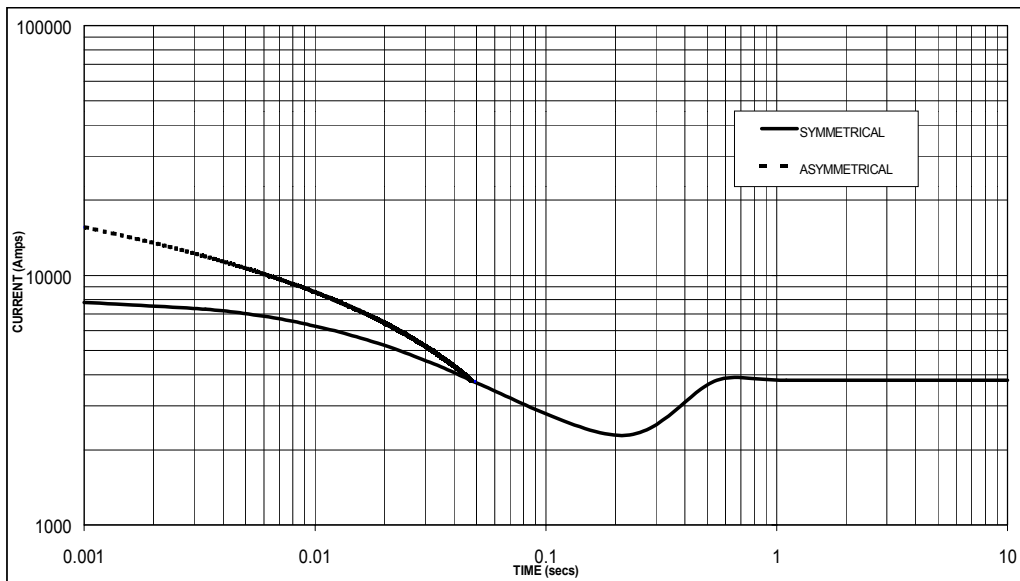

Sustained Short Circuit = 3,800 Amps

Note 1

The following multiplication factors should be used to adjust the values from curve between time 0.001 seconds and the minimum current point in respect of nominal operating voltage :

50Hz		60Hz	
Voltage	Factor	Voltage	Factor
380v	X 1.00	416v	X 1.00
400v	X 1.05	440v	X 1.06
415v	X 1.09	460v	X 1.10
440v	X 1.16	480v	X 1.15

The sustained current value is constant irrespective of voltage level

Note 2

The following multiplication factor should be used to convert the values calculated in accordance with NOTE 1 to those applicable to the various types of short circuit :

	3-phase	2-phase L-L	1-phase L-N
Instantaneous	x 1.00	x 0.87	x 1.30
Minimum	x 1.00	x 1.80	x 3.20
Sustained	x 1.00	x 1.50	x 2.50
Max. sustained duration	10 sec.	5 sec.	2 sec.

All other times are unchanged

Note 3

Curves are drawn for Star (Wye) connected machines.

LVI634B

Winding 312 / 0.8 Power Factor



RATINGS

Class - Temp Rise		Cont. F - 105/40°C				Cont. H - 125/40°C				Standby - 150/40°C				Standby - 163/27°C			
50 Hz	Star (V)	380	400	415	440	380	400	415	440	380	400	415	440	380	400	415	440
	Delta (V)	220	230	240	254	220	230	240	254	220	230	240	254	220	230	240	254
	kVA	651	687	687	623	710	750	750	680	730	775	775	700	745	790	790	715
	kW	521	550	550	498	568	600	600	544	584	620	620	560	596	632	632	572
	Efficiency (%)	93.6	93.6	93.8	94.2	93.2	93.3	93.5	94.0	93.1	93.1	93.3	94.0	93.0	93.0	93.3	93.9
	kW Input	556	587	586	529	609	643	642	579	627	666	665	596	641	680	677	609

60 Hz	Star (V)	416	440	460	480	416	440	460	480	416	440	460	480	416	440	460	480
	Delta (V)	240	254	266	277	240	254	266	277	240	254	266	277	240	254	266	277
	kVA	742	784	820	860	810	855	895	938	840	889	929	970	849	898	939	980
	kW	594	627	656	688	648	684	716	750	672	711	743	776	679	718	751	784
	Efficiency (%)	93.3	93.5	93.6	93.6	93.0	93.1	93.2	93.3	92.8	93.0	93.1	93.1	92.8	92.9	93.0	93.1
	kW Input	636	671	701	735	697	735	768	804	724	765	798	834	732	773	808	842

DIMENSIONS

