

**HCI 534E/544E - Technical Data Sheet**

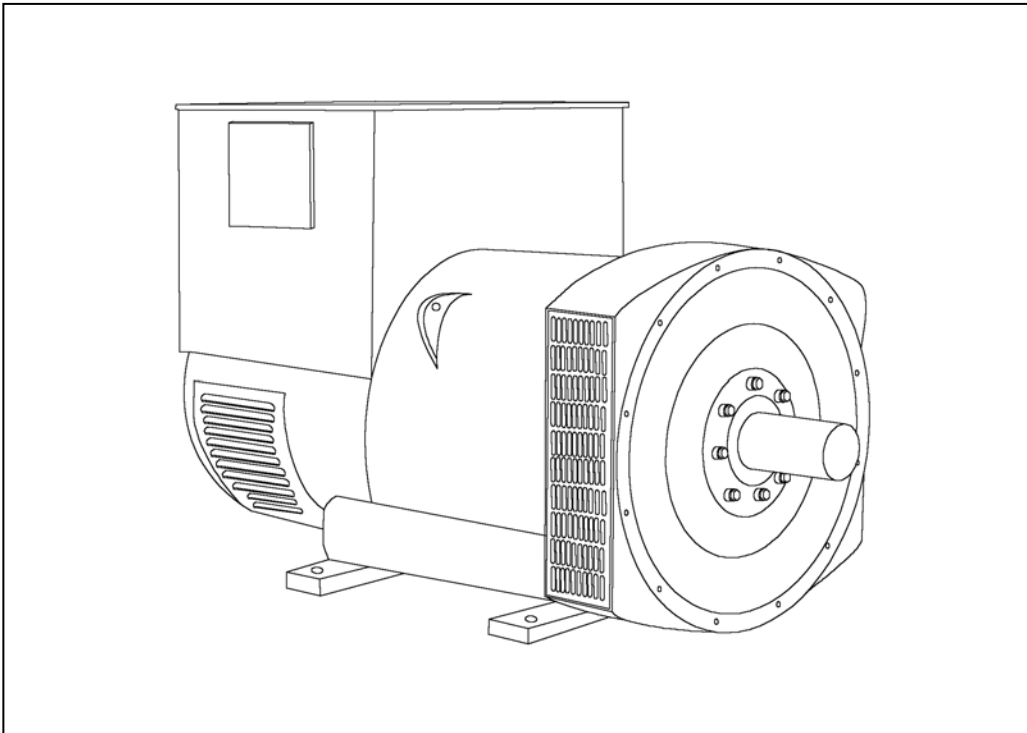

# HCI534E/544E

## SPECIFICATIONS & OPTIONS



### STANDARDS

Newage Stamford industrial generators meet the requirements of BS EN 60034 and the relevant section of other international standards such as BS5000, VDE 0530, NEMA MG1-32, IEC34, CSA C22.2-100, AS1359. Other standards and certifications can be considered on request.

### VOLTAGE REGULATORS

#### SX440 AVR - STANDARD

With this self-excited system the main stator provides power via the Automatic Voltage Regulator (AVR) to the exciter stator. The high efficiency semi-conductors of the AVR ensure positive build-up from initial low levels of residual voltage.

The exciter rotor output is fed to the main rotor through a three-phase full-wave bridge rectifier. The rectifier is protected by a surge suppressor against surges caused, for example, by short circuit or out-of-phase paralleling.

The SX440 will support a range of electronic accessories, including a 'droop' Current Transformer (CT) to permit parallel operation with other ac generators.

If 3-phase sensing is required with the self-excited system, the SX421 AVR must be used.

#### SX421 AVR

This AVR also operates in a self-excited system. It combines all the features of the SX440 with, additionally, three-phase rms sensing for improved regulation and performance. Over voltage protection is provided via a separate circuit breaker. An engine relief load acceptance feature is built in as standard.

#### MX341 AVR

This sophisticated AVR is incorporated into the Stamford Permanent Magnet Generator (PMG) control system.

The PMG provides power via the AVR to the main exciter, giving a source of constant excitation power independent of generator output. The main exciter output is then fed to the main rotor, through a full wave bridge, protected by a surge suppressor. The AVR has in-built protection against sustained over-excitation, caused by internal or external faults. This de-excites the machine after a minimum of 5 seconds.

An engine relief load acceptance feature can enable full load to be applied to the generator in a single step.

If three-phase sensing is required with the PMG system the MX321 AVR must be used.

We recommend three-phase sensing for applications with greatly unbalanced or highly non-linear loads.

#### MX321 AVR

The most sophisticated of all our AVRs combines all the features of the MX341 with, additionally, three-phase rms sensing, for improved regulation and performance.

Over voltage protection is built-in and short circuit current level adjustments is an optional facility.

### WINDINGS & ELECTRICAL PERFORMANCE

All generator stators are wound to 2/3 pitch. This eliminates triplen (3rd, 9th, 15th ...) harmonics on the voltage waveform and is found to be the optimum design for trouble-free supply of non-linear loads. The 2/3 pitch design avoids excessive neutral currents sometimes seen with higher winding pitches, when in parallel with the mains. A fully connected damper winding reduces oscillations during paralleling. This winding, with the 2/3 pitch and carefully selected pole and tooth designs, ensures very low waveform distortion.

### TERMINALS & TERMINAL BOX

Standard generators are 3-phase reconnectable with 12 ends brought out to the terminals, which are mounted on a cover at the non-drive end of the generator. A sheet steel terminal box contains the AVR and provides ample space for the customers' wiring and gland arrangements. It has removable panels for easy access.

### SHAFT & KEYS

All generator rotors are dynamically balanced to better than BS6861:Part 1 Grade 2.5 for minimum vibration in operation. Two bearing generators are balanced with a half key.

### INSULATION/IMPREGNATION

The insulation system is class 'H'.

All wound components are impregnated with materials and processes designed specifically to provide the high build required for static windings and the high mechanical strength required for rotating components.

### QUALITY ASSURANCE

Generators are manufactured using production procedures having a quality assurance level to BS EN ISO 9001.

The stated voltage regulation may not be maintained in the presence of certain radio transmitted signals. Any change in performance will fall within the limits of Criteria 'B' of EN 61000-6-2:2001. At no time will the steady-state voltage regulation exceed 2%.

*NB Continuous development of our products entitles us to change specification details without notice, therefore they must not be regarded as binding.*

*Front cover drawing typical of product range.*

# HCI534E/544E

## WINDING 311

|  |   |         |                          |         |                                    |         |         |         |
|--|---|---------|--------------------------|---------|------------------------------------|---------|---------|---------|
| CONTROL SYSTEM   | SEPARATELY EXCITED BY P.M.G.  |         |                          |         |                                    |         |         |         |
| A.V.R.   | MX321   | MX341   |                          |         |                                    |         |         |         |
| VOLTAGE REGULATION   | ± 0.5 %   | ± 1.0 % | With 4% ENGINE GOVERNING |         |                                    |         |         |         |
| SUSTAINED SHORT CIRCUIT  | REFER TO SHORT CIRCUIT DECREMENT CURVES (page 7)                                    |         |                          |         |                                    |         |         |         |
| CONTROL SYSTEM   | SELF EXCITED  |         |                          |         |                                    |         |         |         |
| A.V.R.   | SX440   | SX421   |                          |         |                                    |         |         |         |
| VOLTAGE REGULATION   | ± 1.0 %   | ± 0.5 % | With 4% ENGINE GOVERNING |         |                                    |         |         |         |
| SUSTAINED SHORT CIRCUIT  | SERIES 4 CONTROL DOES NOT SUSTAIN A SHORT CIRCUIT CURRENT                           |         |                          |         |                                    |         |         |         |
| INSULATION SYSTEM  | CLASS H   |         |                          |         |                                    |         |         |         |
| PROTECTION   | IP23  |         |                          |         |                                    |         |         |         |
| RATED POWER FACTOR   | 0.8   |         |                          |         |                                    |         |         |         |
| STATOR WINDING   | DOUBLE LAYER LAP  |         |                          |         |                                    |         |         |         |
| WINDING PITCH  | TWO THIRDS  |         |                          |         |                                    |         |         |         |
| WINDING LEADS  | 12  |         |                          |         |                                    |         |         |         |
| STATOR WDG. RESISTANCE   | 0.0043 Ohms PER PHASE AT 22°C SERIES STAR CONNECTED                                 |         |                          |         |                                    |         |         |         |
| ROTOR WDG. RESISTANCE  | 1.96 Ohms at 22°C   |         |                          |         |                                    |         |         |         |
| R.F.I. SUPPRESSION   | BS EN 61000-6-2 & BS EN 61000-6-4,VDE 0875G, VDE 0875N. refer to factory for others |         |                          |         |                                    |         |         |         |
| WAVEFORM DISTORTION  | NO LOAD < 1.5% NON-DISTORTING BALANCED LINEAR LOAD < 5.0%                           |         |                          |         |                                    |         |         |         |
| MAXIMUM OVERSPEED  | 2250 Rev/Min  |         |                          |         |                                    |         |         |         |
| BEARING DRIVE END  | BALL. 6220 (ISO)  |         |                          |         |                                    |         |         |         |
| BEARING NON-DRIVE END  | BALL. 6314 (ISO)  |         |                          |         |                                    |         |         |         |
|  | 1 BEARING   |         |                          |         | 2 BEARING                          |         |         |         |
| WEIGHT COMP. GENERATOR   | 1543 kg   |         |                          |         | 1535 kg                            |         |         |         |
| WEIGHT WOUND STATOR  | 722 kg  |         |                          |         | 722 kg                             |         |         |         |
| WEIGHT WOUND ROTOR   | 617 kg  |         |                          |         | 588 kg                             |         |         |         |
| WR <sup>2</sup> INERTIA  | 8.9828 kgm <sup>2</sup>   |         |                          |         | 8.7049 kgm <sup>2</sup>            |         |         |         |
| SHIPPING WEIGHTS in a crate  | 1635 kg   |         |                          |         | 1625 kg                            |         |         |         |
| PACKING CRATE SIZE   | 166 x 87 x 124(cm)  |         |                          |         | 166 x 87 x 124(cm)                 |         |         |         |
|  | 50 Hz   |         |                          |         | 60 Hz                              |         |         |         |
| TELEPHONE INTERFERENCE   | THF<2%  |         |                          |         | TIF<50                             |         |         |         |
| COOLING AIR  | 1.035 m <sup>3</sup> /sec 2202 cfm  |         |                          |         | 1.312 m <sup>3</sup> /sec 2780 cfm |         |         |         |
| VOLTAGE SERIES STAR  | 380/220   | 400/231 | 415/240                  | 440/254 | 416/240                            | 440/254 | 460/266 | 480/277 |
| VOLTAGE PARALLEL STAR  | 190/110   | 200/115 | 208/120                  | 220/127 | 208/120                            | 220/127 | 230/133 | 240/138 |
| VOLTAGE SERIES DELTA   | 220/110   | 230/115 | 240/120                  | 254/127 | 240/120                            | 254/127 | 266/133 | 277/138 |
| KVA BASE RATING FOR REACTANCE VALUES   | 600   | 600     | 600                      | 600     | 681                                | 713     | 731     | 750     |
| X <sub>d</sub> DIR. AXIS SYNCHRONOUS   | 3.14  | 2.83    | 2.63                     | 2.34    | 3.53                               | 3.30    | 3.10    | 2.92    |
| X' <sub>d</sub> DIR. AXIS TRANSIENT  | 0.17  | 0.15    | 0.14                     | 0.12    | 0.17                               | 0.16    | 0.15    | 0.14    |
| X'' <sub>d</sub> DIR. AXIS SUBTRANSIENT                                      | 0.12  | 0.11    | 0.10                     | 0.09    | 0.12                               | 0.11    | 0.11    | 0.10    |
| X <sub>q</sub> QUAD. AXIS REACTANCE  | 2.45  | 2.21    | 2.05                     | 1.82    | 2.82                               | 2.64    | 2.48    | 2.33    |
| X'' <sub>q</sub> QUAD. AXIS SUBTRANSIENT                                     | 0.26  | 0.24    | 0.22                     | 0.20    | 0.34                               | 0.32    | 0.30    | 0.28    |
| X <sub>L</sub> LEAKAGE REACTANCE   | 0.06  | 0.05    | 0.05                     | 0.04    | 0.06                               | 0.06    | 0.05    | 0.05    |
| X <sub>2</sub> NEGATIVE SEQUENCE   | 0.18  | 0.16    | 0.15                     | 0.13    | 0.23                               | 0.22    | 0.20    | 0.19    |
| X <sub>0</sub> ZERO SEQUENCE   | 0.08  | 0.08    | 0.07                     | 0.06    | 0.10                               | 0.09    | 0.09    | 0.08    |
| REACTANCES ARE SATURATED VALUES ARE PER UNIT AT RATING AND VOLTAGE INDICATED |   |         |                          |         |                                    |         |         |         |
| T' <sub>d</sub> TRANSIENT TIME CONST.  | 0.08s   |         |                          |         |                                    |         |         |         |
| T'' <sub>d</sub> SUB-TRANSTIME CONST.  | 0.012s  |         |                          |         |                                    |         |         |         |
| T' <sub>do</sub> O.C. FIELD TIME CONST.                                      | 2.5s  |         |                          |         |                                    |         |         |         |
| T <sub>a</sub> ARMATURE TIME CONST.  | 0.019s  |         |                          |         |                                    |         |         |         |
| SHORT CIRCUIT RATIO  | 1/X <sub>d</sub>  |         |                          |         |                                    |         |         |         |

**50  
Hz**

**HCI534E/544E**  
Winding 311



**THREE PHASE EFFICIENCY CURVES**

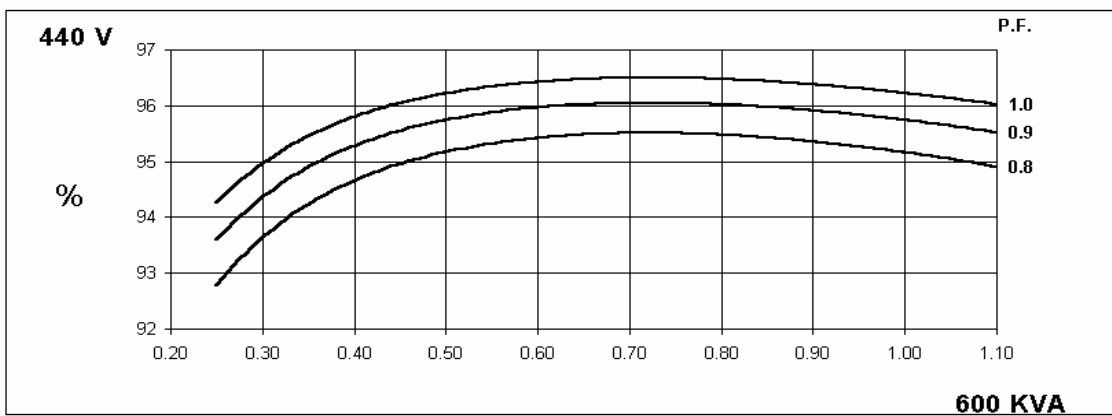
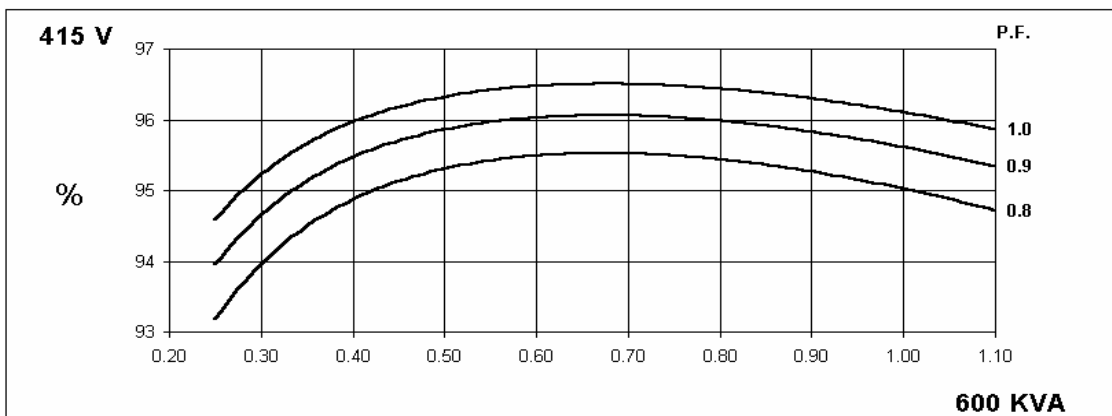
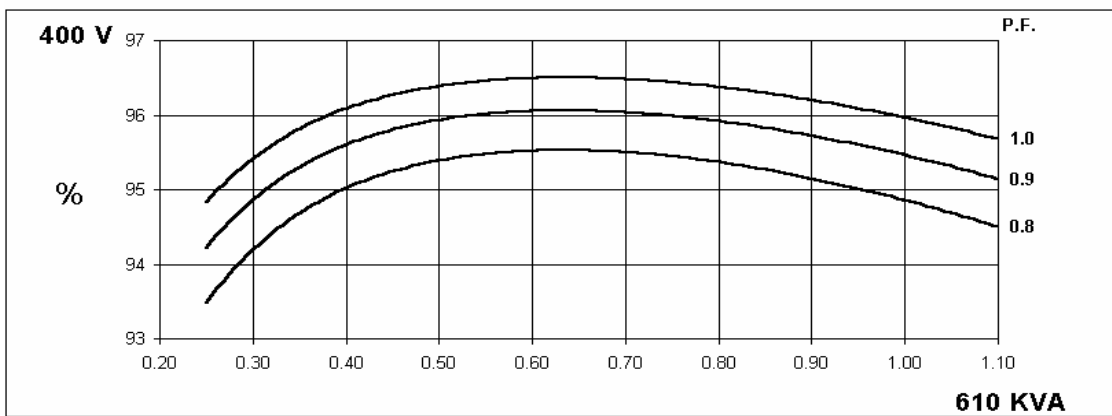
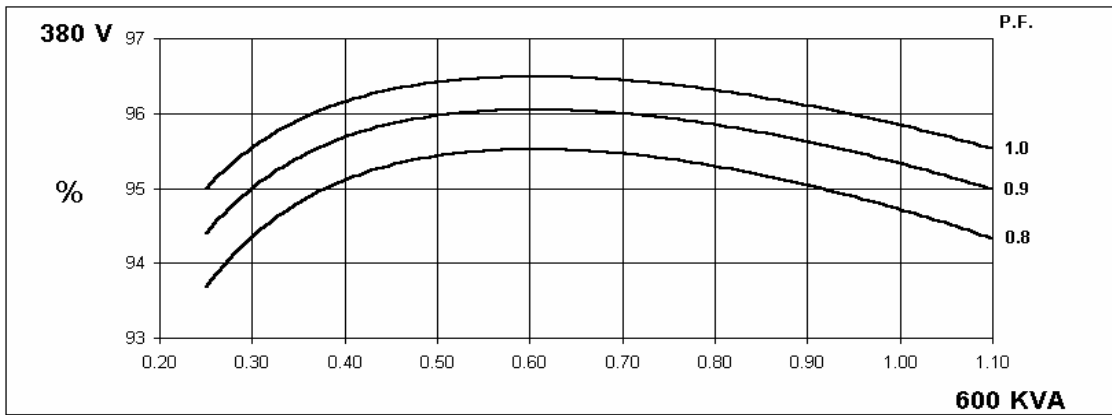

**THREE PHASE EFFICIENCY CURVES**

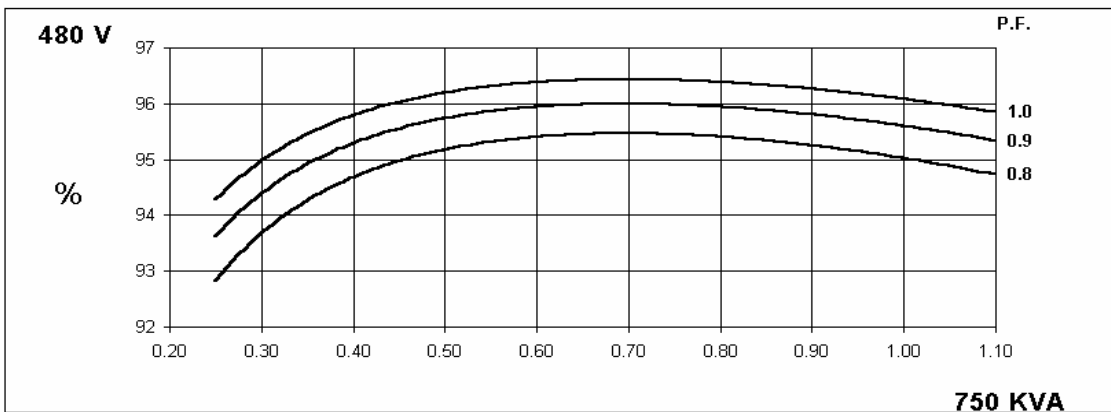
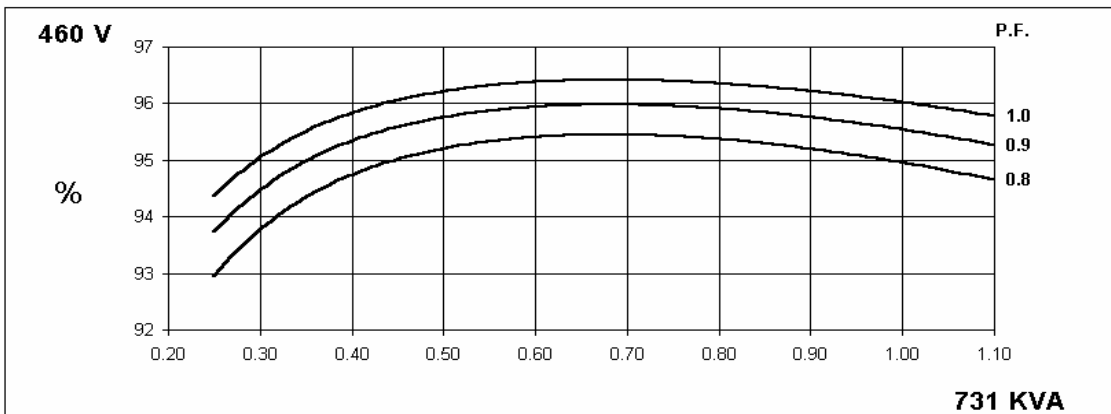
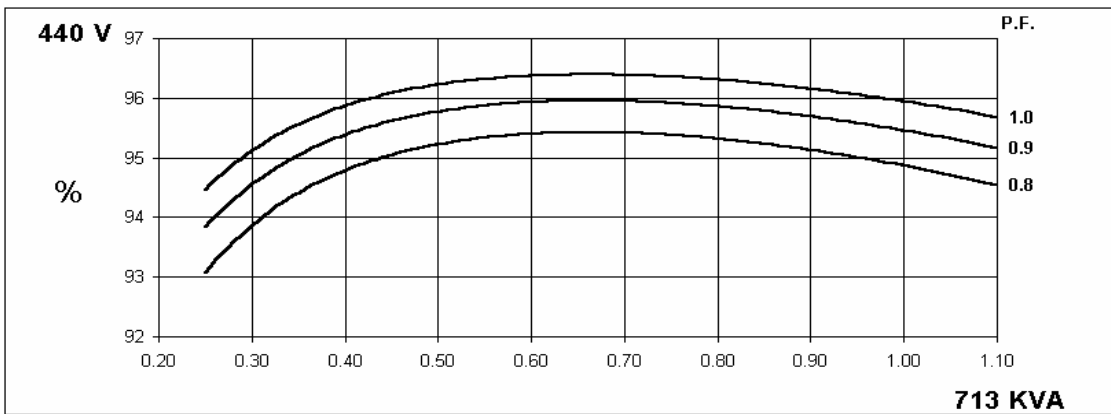
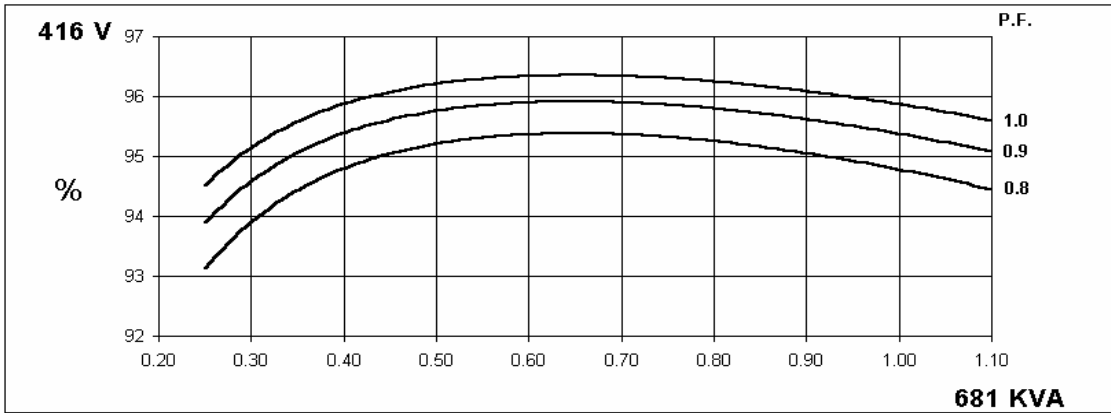

# HCI534E/544E

Winding 311



## Locked Rotor Motor Starting Curve

**50  
Hz**

**MX**

**SX**

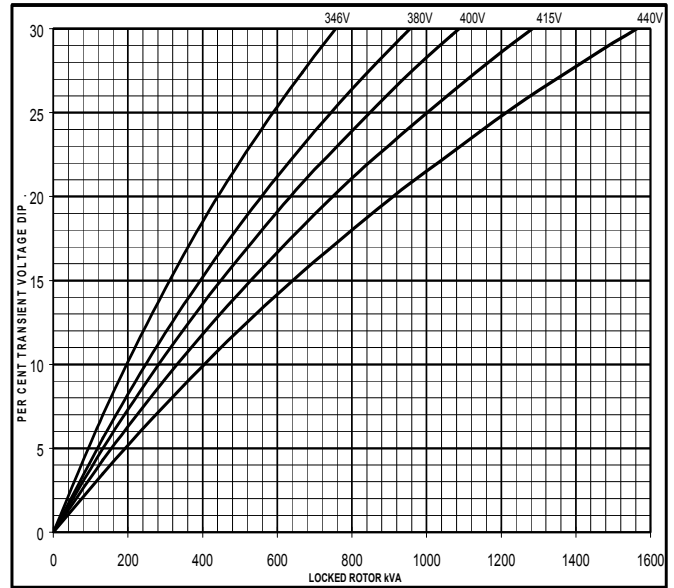
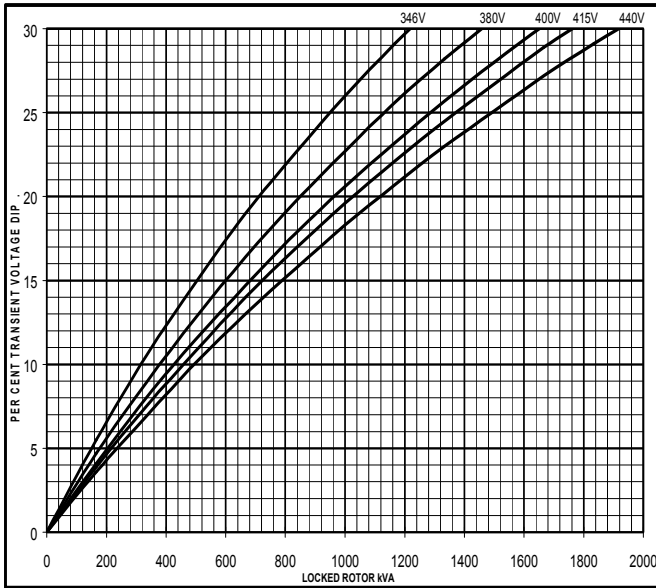

**60  
Hz**

**MX**

**SX**

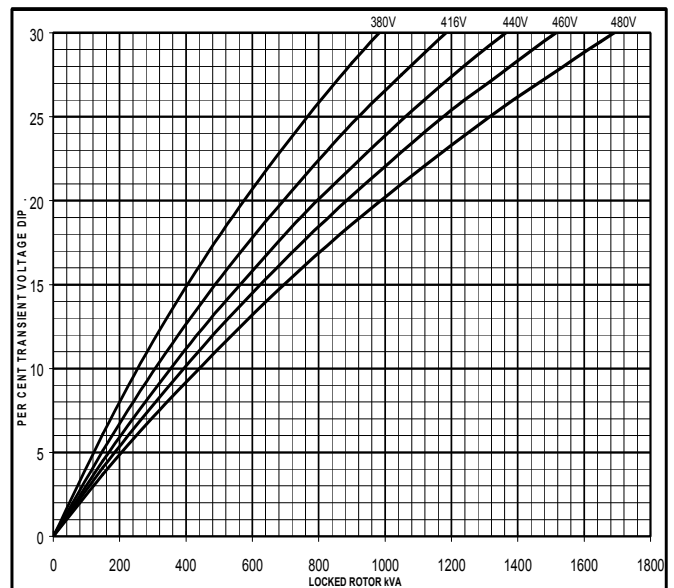
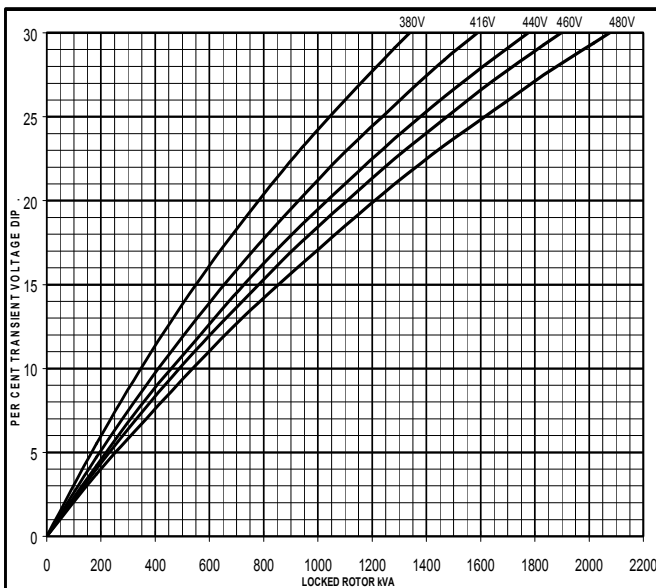

**Three-phase Short Circuit Decrement Curve. No-load Excitation at Rated Speed  
Based on star (wye) connection.**

**50  
Hz**

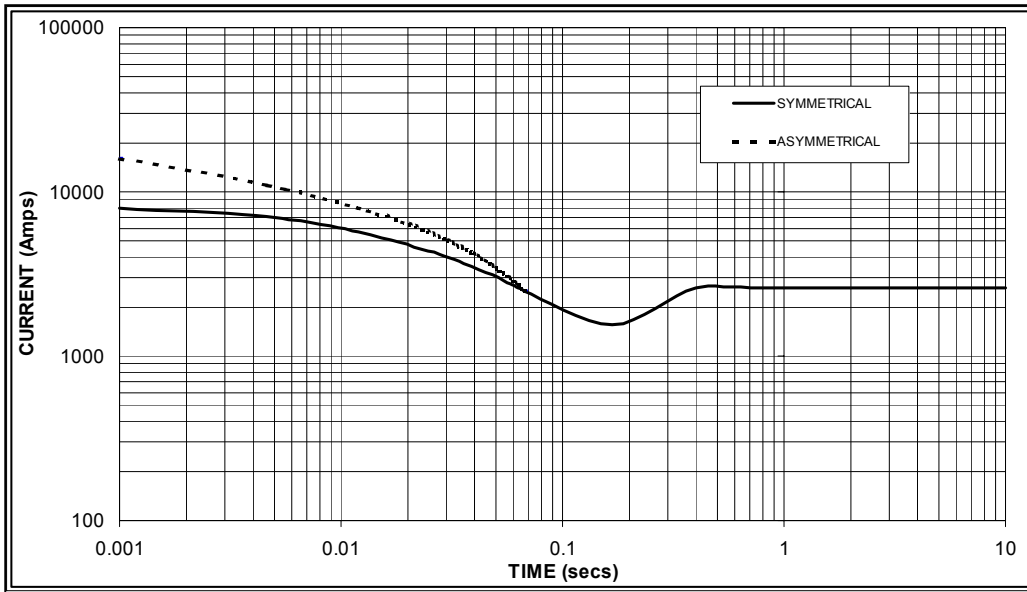

Sustained Short Circuit = 2,600 Amps

**60  
Hz**

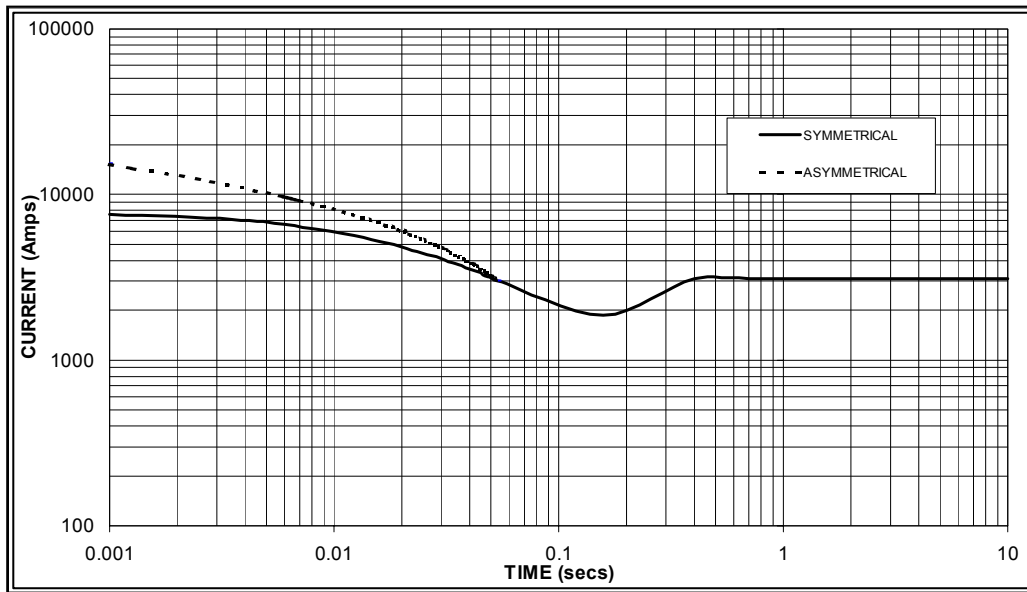

Sustained Short Circuit = 3,100 Amps

**Note 1**

The following multiplication factors should be used to adjust the values from curve between time 0.001 seconds and the minimum current point in respect of nominal operating voltage :

| 50Hz    |        | 60Hz    |        |
|---------|--------|---------|--------|
| Voltage | Factor | Voltage | Factor |
| 380v    | X 1.00 | 416v    | X 1.00 |
| 400v    | X 1.06 | 440v    | X 1.06 |
| 415v    | X 1.09 | 460v    | X 1.12 |
| 440v    | X 1.12 | 480v    | X 1.20 |

The sustained current value is constant irrespective of voltage level

**Note 2**

The following multiplication factor should be used to convert the values calculated in accordance with NOTE 1 to those applicable to the various types of short circuit :

|                         | 3-phase | 2-phase L-L | 1-phase L-N |
|-------------------------|---------|-------------|-------------|
| Instantaneous           | x 1.00  | x 0.87      | x 1.30      |
| Minimum                 | x 1.00  | x 1.80      | x 3.20      |
| Sustained               | x 1.00  | x 1.50      | x 2.50      |
| Max. sustained duration | 10 sec. | 5 sec.      | 2 sec.      |

All other times are unchanged

**Note 3**

Curves are drawn for Star (Wye) connected machines. For other connection the following multipliers should be applied to current values as shown :

Parallel Star = Curve current value X 2

Series Delta = Curve current value X 1.732

# HCI534E/544E

Winding 311 0.8 Power Factor



## RATINGS

| Class - Temp Rise | Cont. F - 105/40°C |      |      |      | Cont. H - 125/40°C |      |      |      | Standby - 150/40°C |      |      |      | Standby - 163/27°C |      |      |      |     |
|-------------------|--------------------|------|------|------|--------------------|------|------|------|--------------------|------|------|------|--------------------|------|------|------|-----|
| <b>50 Hz</b>      | Series Star (V)    | 380  | 400  | 415  | 440                | 380  | 400  | 415  | 440                | 380  | 400  | 415  | 440                | 380  | 400  | 415  | 440 |
|                   | Parallel Star (V)  | 190  | 200  | 208  | 220                | 190  | 200  | 208  | 220                | 190  | 200  | 208  | 220                | 190  | 200  | 208  | 220 |
|                   | Series Delta (V)   | 220  | 230  | 240  | 254                | 220  | 230  | 240  | 254                | 220  | 230  | 240  | 254                | 220  | 230  | 240  | 254 |
| kVA               | 550                | 560  | 550  | 550  | 600                | 610  | 600  | 600  | 636                | 640  | 636  | 636  | 660                | 665  | 660  | 660  |     |
| kW                | 440                | 448  | 440  | 440  | 480                | 488  | 480  | 480  | 509                | 512  | 509  | 509  | 528                | 532  | 528  | 528  |     |
| Efficiency (%)    | 95.0               | 95.1 | 95.2 | 95.3 | 94.7               | 94.9 | 95.0 | 95.2 | 94.5               | 94.7 | 94.8 | 95.0 | 94.3               | 94.5 | 94.7 | 94.9 |     |
| kW Input          | 463                | 471  | 462  | 462  | 507                | 514  | 505  | 504  | 538                | 541  | 537  | 536  | 560                | 563  | 558  | 556  |     |

|                |                   |      |      |      |      |      |      |      |      |      |      |      |      |      |      |      |     |
|----------------|-------------------|------|------|------|------|------|------|------|------|------|------|------|------|------|------|------|-----|
| <b>60 Hz</b>   | Series Star (V)   | 416  | 440  | 460  | 480  | 416  | 440  | 460  | 480  | 416  | 440  | 460  | 480  | 416  | 440  | 460  | 480 |
|                | Parallel Star (V) | 208  | 220  | 230  | 240  | 208  | 220  | 230  | 240  | 208  | 220  | 230  | 240  | 208  | 220  | 230  | 240 |
|                | Delta (V)         | 240  | 254  | 266  | 277  | 240  | 254  | 266  | 277  | 240  | 254  | 266  | 277  | 240  | 254  | 266  | 277 |
| kVA            | 625               | 650  | 663  | 675  | 681  | 713  | 731  | 750  | 719  | 750  | 780  | 800  | 738  | 769  | 798  | 819  |     |
| kW             | 500               | 520  | 530  | 540  | 545  | 570  | 585  | 600  | 575  | 600  | 624  | 640  | 590  | 615  | 638  | 655  |     |
| Efficiency (%) | 95.0              | 95.1 | 95.2 | 95.3 | 94.8 | 94.9 | 95.0 | 95.0 | 94.6 | 94.7 | 94.8 | 94.8 | 94.5 | 94.6 | 94.7 | 94.8 |     |
| kW Input       | 526               | 547  | 557  | 567  | 575  | 601  | 616  | 632  | 608  | 634  | 658  | 675  | 625  | 650  | 674  | 691  |     |

## DIMENSIONS

